



F001

TOWNHOUSE

Difficulty Level:



TOWNHOUSE

A lined bag with appliquéd mini pockets and a drawstring closure.

SMALL BAG

6" x 9" x 3"

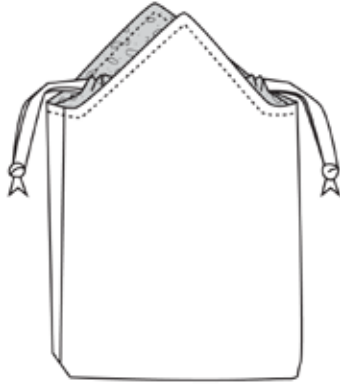

LARGE BAG

10" x 13" x 5"

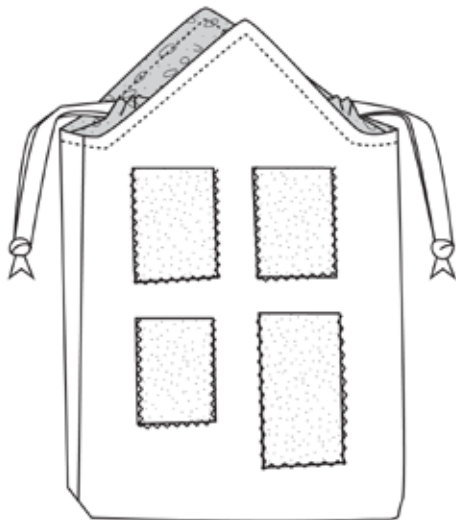

DIFFICULTY

Advanced Beginner

SEAM ALLOWANCE

1/2" allowed on all seams

SUPPLIES

Small bag: 1/2* yard of Outer fabric

Large bag: 3/4 yard of Outer fabric

✂ Heavy weight stiff fabrics like canvas, denim, twill, heavy linen.

- or -

✂ Medium weight stable fabric like quilting cotton, linen, sateen **to be used with interfacing**

Small bag: 5/8* yard of Lining fabric

Large bag: 7/8 yard of Lining fabric

✂ Medium to light weight fabric like quilting cotton, satin, rayon, voile, lawn, double gauze.

Other Supplies

✂ Matching thread

✂ **If using medium weight outer fabric:**
1/2 yard (small) or 3/4 yard (large) of medium weight fusible interfacing

✂ 1 1/2 yards (small) or 2 yards (large) or 1" twill tape or ribbon

Optional Supplies

✂ **For appliqué:** One sheet each of black and brown felt

✂ **For top closure:** 1 large snap

✂ **For handle/strap:** 1/2 yard 1" or 1 1/2" wide cotton webbing

* If you are not using a fabric with a directional texture or print, you can cut both outer and lining fabric on the cross grain, which would require 3/8 yd of each fabric.

CUT YOUR FABRIC

For help prepping your fabric & other tips, visit Blueprintsforsewing.com/tutorials

1. Fold your fabric in half, wrong side facing out, matching the selvages.
2. Lay out pattern pieces as shown. Trace around your pieces with chalk then cut, or pin your pattern pieces to the fabric and cut around them.
3. Mark all circles using chalk or pen. If doing appliqué, mark the appliqué placement lines on the right side of the fabric.

CUTTING LAYOUT



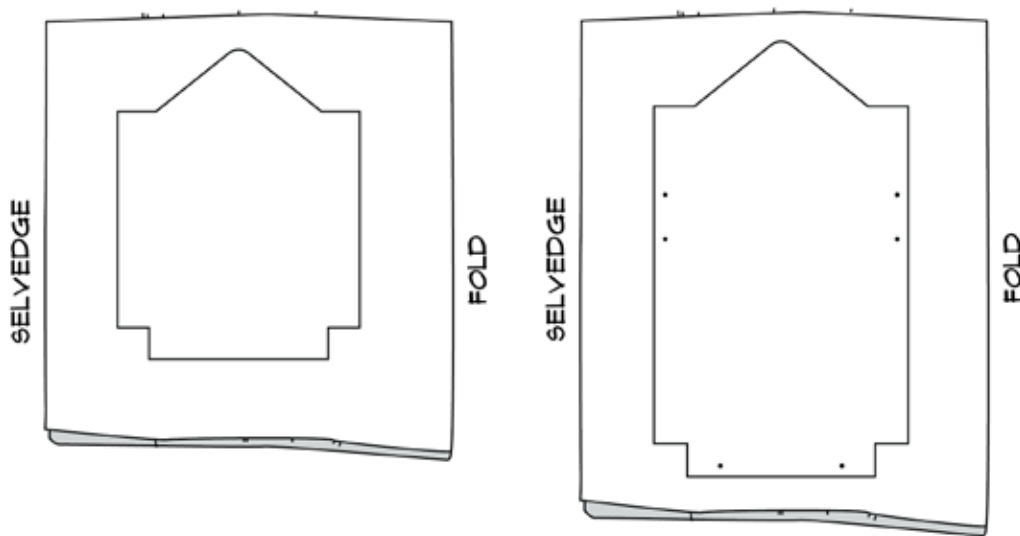

Small & Large Bag

45-60" fabric



If making the small bag, both outer and lining fabrics can be cut on the cross grain to conserve fabric. In this case, both pieces require 3/8 yard. You could also use large scraps or fat quarters.

4. SEWING INSTRUCTIONS

-  Right side of outer fabric
-  Right side of lining fabric
-  Wrong side of fabric
-  Interfacing

1. If using a medium/light weight fabric, fuse interfacing to the wrong sides of both outer pieces.

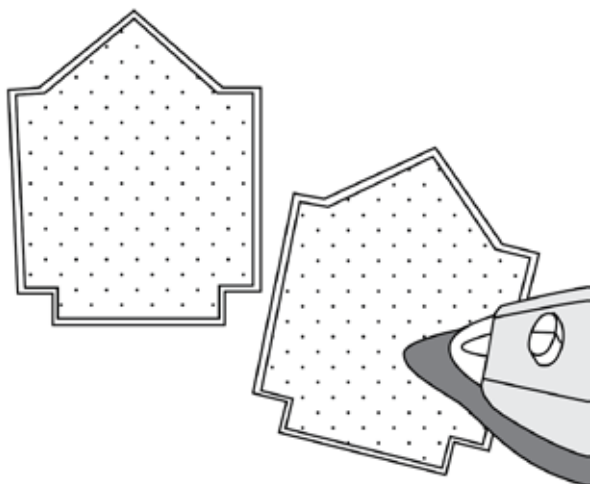

2. **Optional:** Cut out appliqué windows and door from felt. Place them onto one of the outer pieces as indicated on the pattern. To create pockets, sew around three sides of each appliqué.

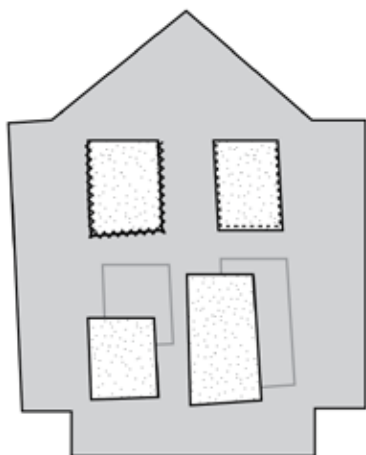

To omit pockets, sew around all four sides. You can use a zigzag stitch to overcast the edge or a straight stitch 1/8" from the edge.

➤ You can also use scraps of fabric instead of felt. Use a wide zig zag stitch to overcast the edges of the fabric as you stitch it on.

3. Sew together the two outer and two lining pieces, right sides together. On the lining pieces, do not sew between the two dots on each side.

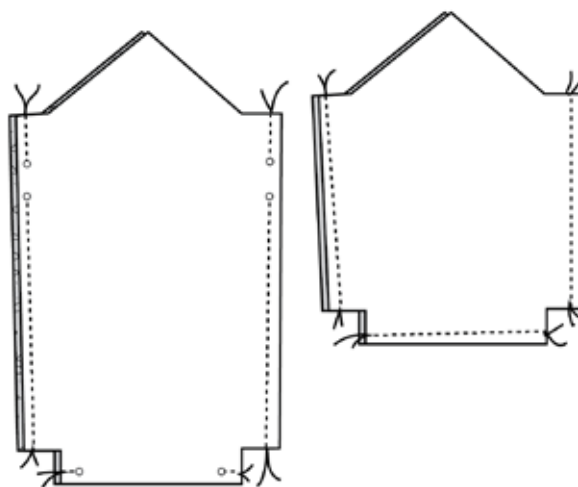

4. On both outer bag and lining, press the seam allowances open.

➤ Place the bag over the end of the ironing board to make pressing seam allowances easier.

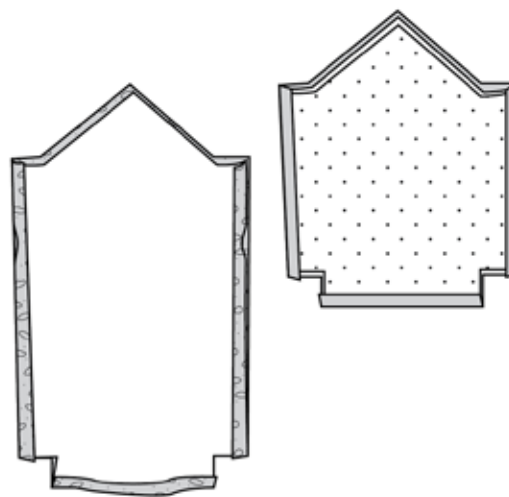

5. On the bag lining, stitch around each opening along the side seam, 1/4" from the opening.

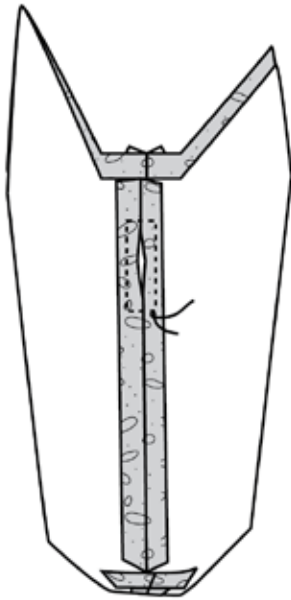

For the **large bag**, fold down the lining 6", then sew around the opening 4" from the folded edge.

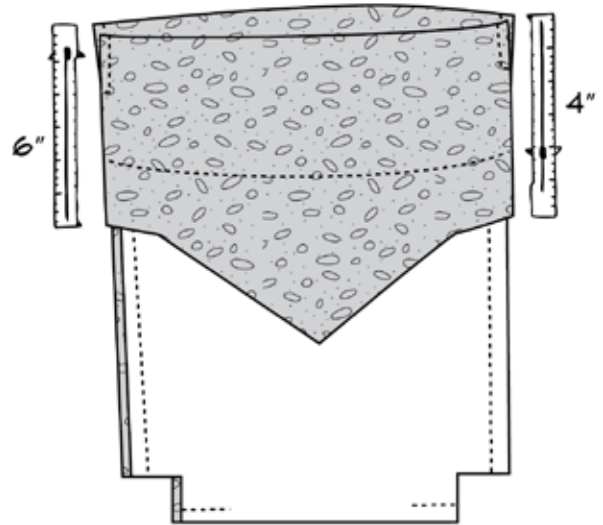

6. To create the drawstring casing, fold back the lining as though you're folding a cuff. You will then sew through both layers around the bag opening. The distance to fold down the lining and how far away from the edge to stitch is shown for each bag:

➔ Since your sewing machine doesn't have markings for 2.5" or 4", use a ruler to measure that distance away from the needle and place a piece of masking tape on the bed of your machine to use as a guide.

For the **small bag**, fold down the top of the lining 5" and pin in place. Then, stitch around the bag opening (as though sewing a cuff) 2.5" from the folded edge.

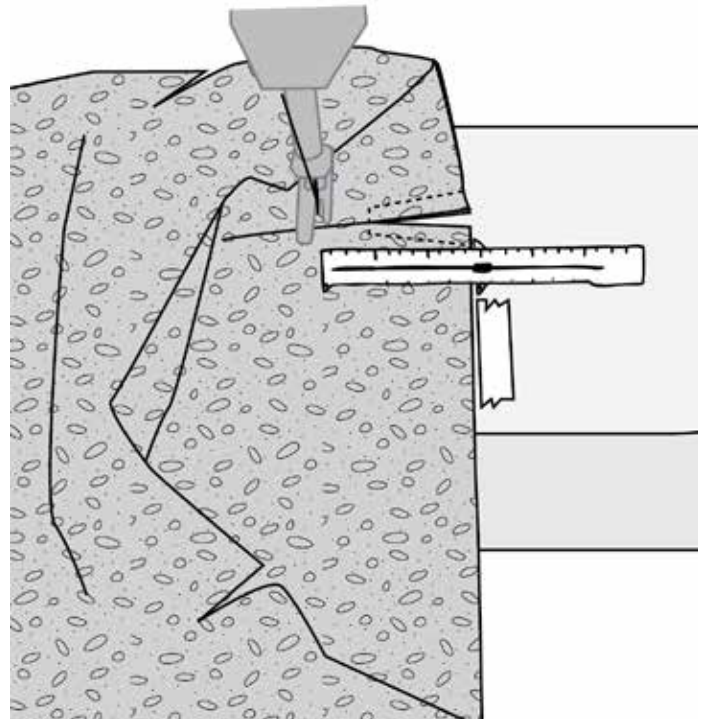
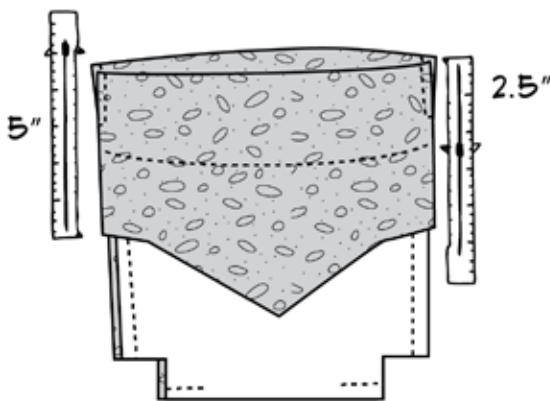

7. If making the larger bag, do another round of stitching 1" away from the folded edge.

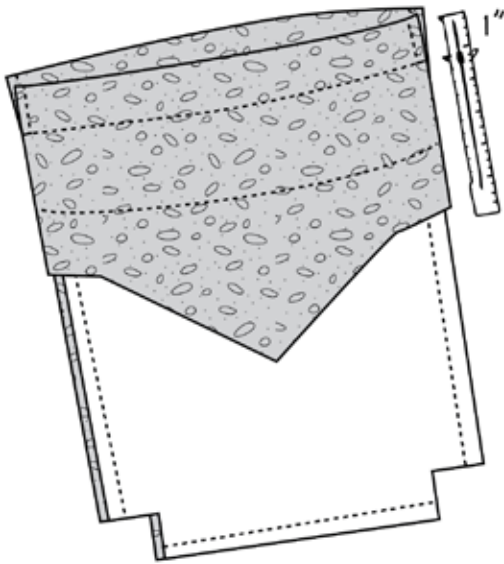

9. Once sewn, both outer and lining bags should look like this:

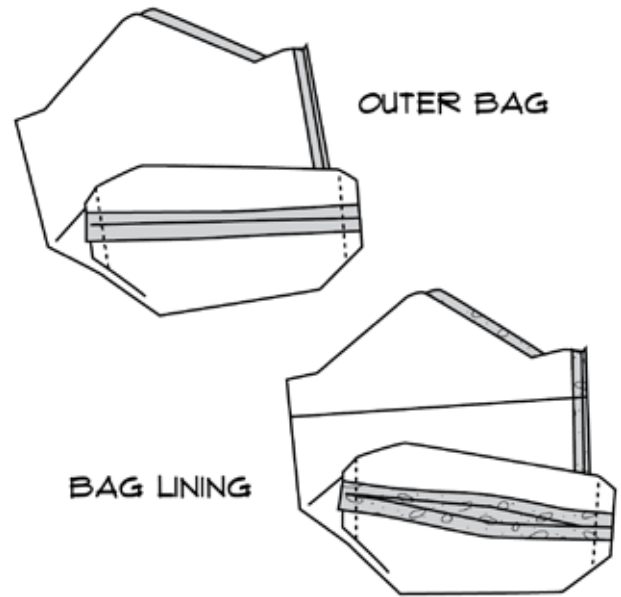

8. On both the outer and lining pieces, pinch closed the openings where the bottom and side seam meet and sew them closed. The seams and fabric edge should match up.

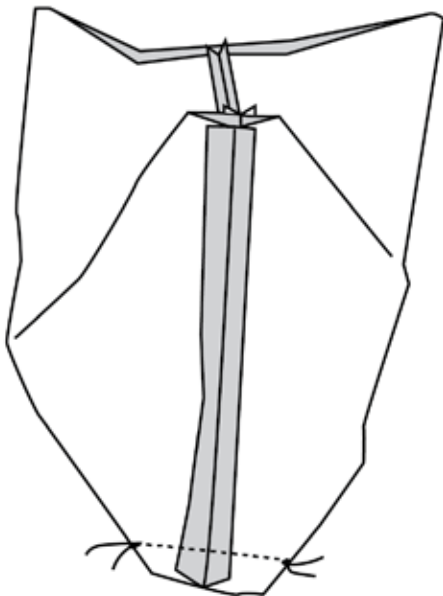

10. With the outer bag inside out, place the lining bag right side out inside of it, matching up the 'roof' of the bags.

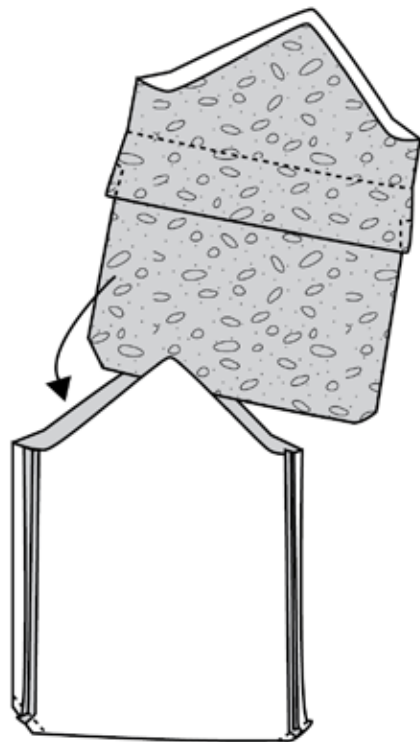

11. Sew the two bags together around the opening.

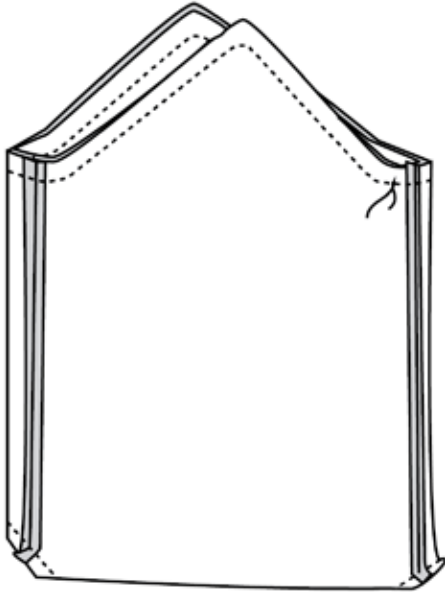

12. Clip the corners of the seam allowance and trim the pointed part of the roof down to 1/8". This will keep the roof edge from puckering once it's turned inside out.

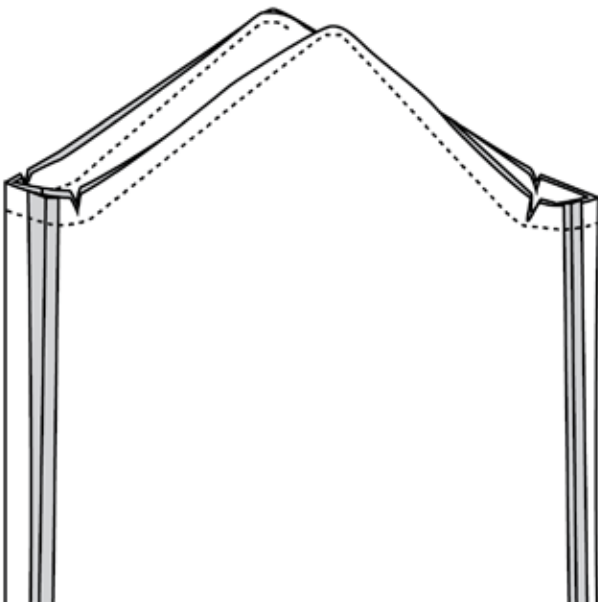

13. Reach into the bag and pull out the lining. Then reach through the opening in the lining and pull it down over the outer bag.

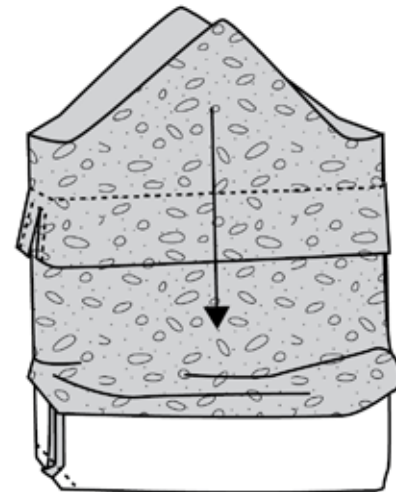
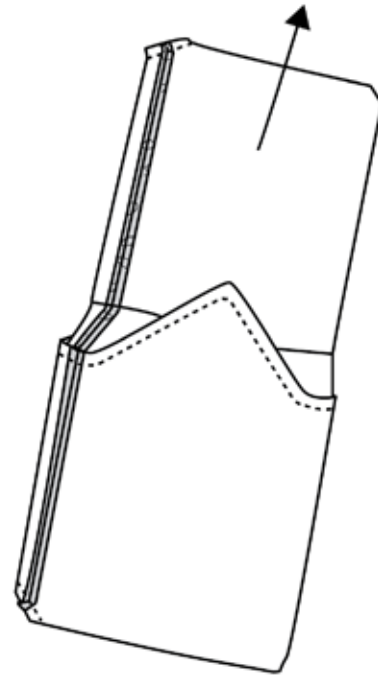

14. Once the lining is turned out to the right side, reach into it and poke out the corners of each roof part to make a nice point. Press along the top edge.

15. Reach through the lining opening on the bottom of the bag and grab the bottom corner seam of the outer fabric and pin it to the lining corner. Sew the two seam allowances together. Repeat this step with the other two bottom corner seam allowances. This step helps to keep the lining in place.

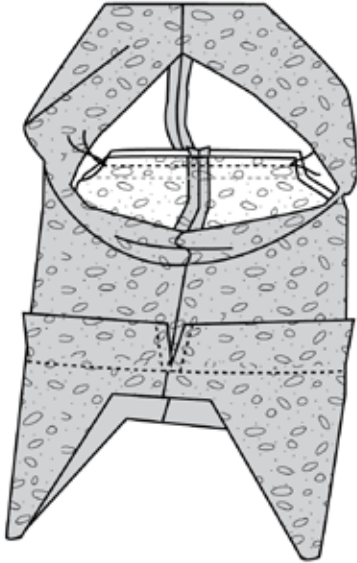

➔ In this illustration, the wrong side of the lining fabric is shown as a white version of the lining pattern, to differentiate between the outer fabric corner and lining fabric corner.

16. Close up the opening in the bottom of the lining by hand or machine.



17. Cut your twill tape or ribbon into two equal pieces. Thread one piece through one side of the casing, then back through the other. Tie the two ends together.

Take the remaining piece and thread it through in the same way but from the opposite side. Tie the two ends together.

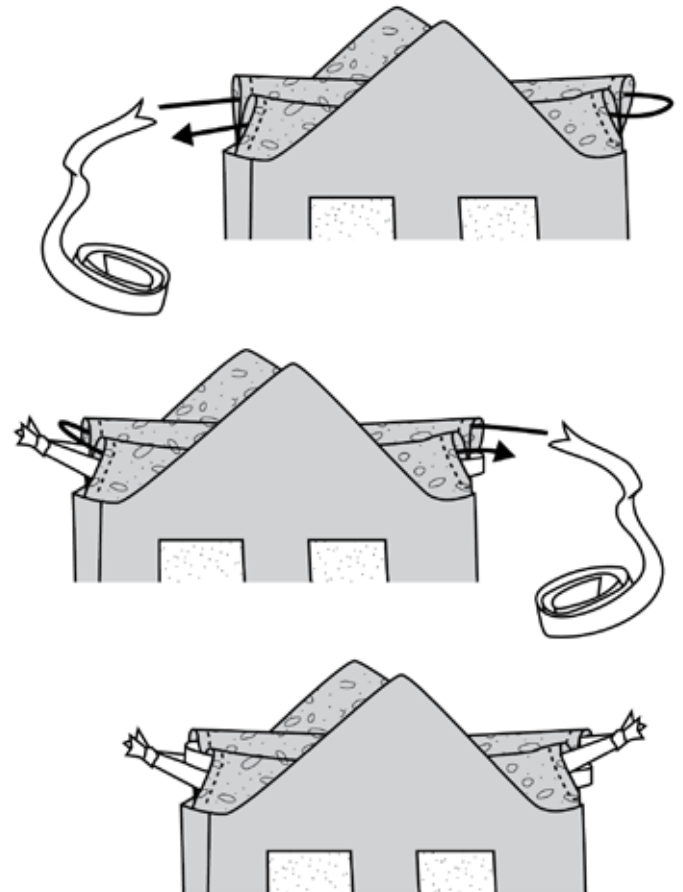

➔ This creates a drawstring closure that scrunches up easily and evenly by pulling from both ends.

18. **Optional:** Top stitch around the bag opening 1/4" away from the edge by machine or by hand using embroidery floss.

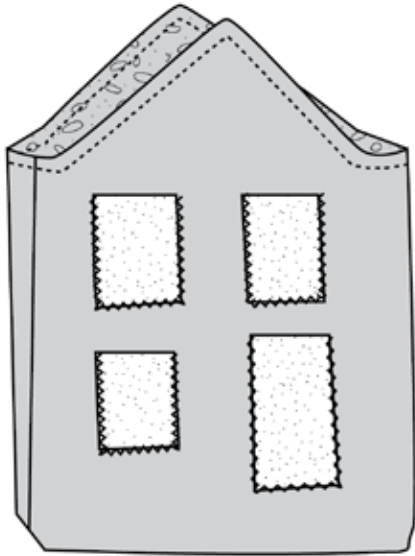

VARIATIONS

➔ Add straps or a handle to your bag by attaching 1" or 1 1/2" wide cotton webbing to each side of the bag, securing with a square of stitching. Try 1/2 yard for a handle and 1 yard for a shoulder bag.

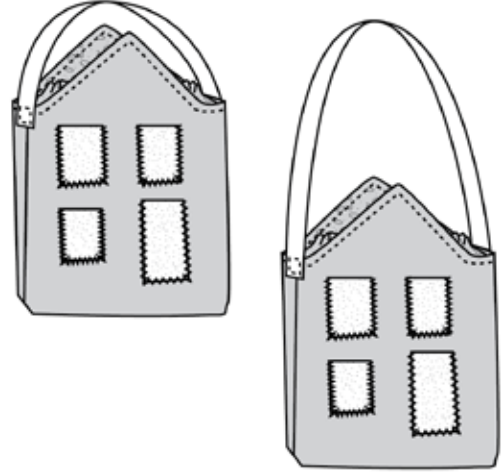

19. Admire your finished bag! Use it to wrap a special gift, keep your knitting and crafting projects organized, store shoes & clothes, and more.

➔ Add a snap at the top of the roof section to keep the bag closed.

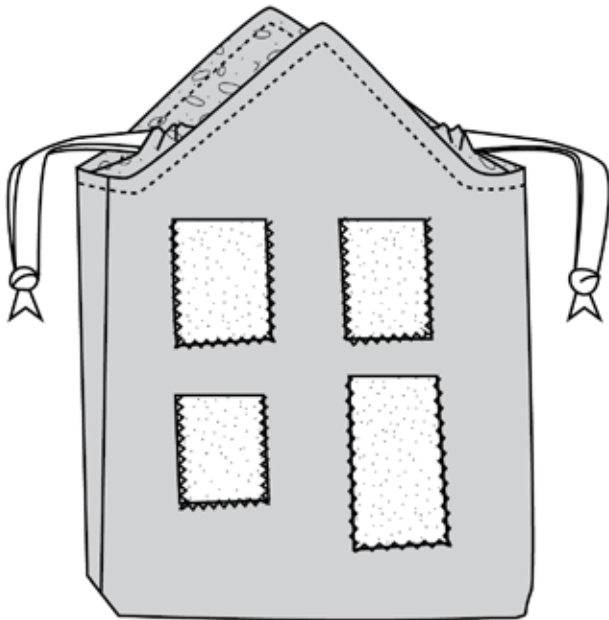
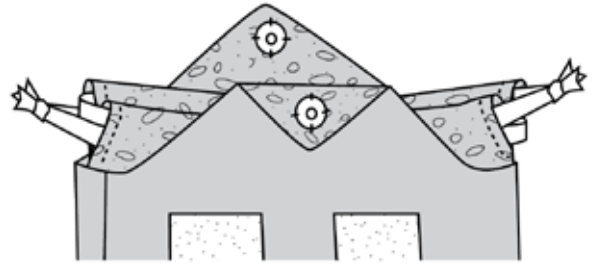

➔ Add additional embroidery to decorate your townhouse in your favorite style.

